

HAAS
+
SOHN

Warmth. Salzburg style.

QUALITY TIMES

COLLECTION 2018/19

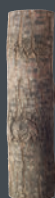

PREMIUM



CONTENT



HIGHLIGHTS

Quality times with HAAS+SOHN 3
Service 4
Clean technology 7

FIREPLACE STOVES

Introduction 3
Product Highlights 4
Product Highlights i-Control
Fireplace stoves 7

FIREPLACE STOVES WITH HEAT EXCHANGER

Product Highlights 8
Fireplace stoves
with heat exchanger 10
22
24

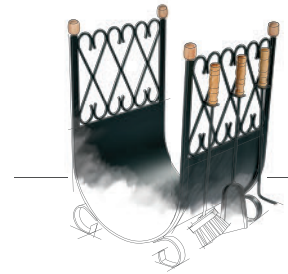

PELLET STOVES

Introduction 26
Product Highlights 28
Pellet stoves 30

PELLET STOVES WITH HEAT EXCHANGER

Product Highlights 31
Pellet stoves
with heat exchanger 33

ACCESSORIES

Fireplace tools, cleaning sprays,
draught controllers, repairing sprays 35
Glass floor plates 36
Technical parameters 37





QUALITY TIMES

Warmth. Salzburg style.





QUALITY TIMES WITH HAAS+SOHN

We are intelligent warmth by design
– from Salzburg.

The rich quality of life is treasured in Salzburg – breathtaking landscapes, unspoilt nature, exquisite cuisine, world-class art and culture and a city that imparts the cosy feeling of a village despite its significance. We have made it our mission to share with you a piece of this way of life: our ovens and stoves not only provide heat, but also spread well-being and joy. With their noble design and outstanding quality, they are an additional element of what makes the international reputation of Salzburg. Our large competence centre for research, development and design in Salzburg guarantees that even in the future, we will do everything to more than fulfil our promise to you.

Our vision:

We define new standards in precision, service and comfort for the individual way of life and thereby ensure that you have

QUALITY TIMES



Long-term availability of parts also for older models



Simple and convenient ordering of spare parts from our partners in your country



Professional customer services via our partners – a professionally trained service technician is immediately at your disposal



Quick support nation-wide

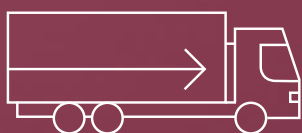

More than 4,000 permanently available items in the spare parts warehouse ensure quick delivery



Manuals and technical data sheets are available for download from our website



YOUR SERVICE-PLUS

Our promise to you.

Our relationship with the customer does not end upon purchase. We guarantee the best care to you in case of service.

Regardless of how old your stove is!





TODAY, WE ALREADY ACT FOR THE FUTURE

CLEAN TECHNOLOGY for a clean and safe future.

Heating in a traditional and at the same time innovative way - our stoves and fireplace inserts make this possible. We invest a lot of effort and ingenuity in the development of our products in order to prepare them for the future. Continuous forecasting of future development and innovation together with more than 160 years of experience are our key to success.



At present, our products already fulfil the requirements of all-European emission regulations, which shall come into force in 2022. Our "CLEAN TECHNOLOGY" quality seal as a symbol of our internal ecological guidelines is used on stoves and fireplace inserts to indicate their ecological friendliness and long-term safety - because our own demands for the cleanliness and efficiency of our products are for that matter even stricter than the EU standards! All our fireplace and pellet stoves and fireplace inserts fulfil the CLEAN TECHNOLOGY seal guideline requirements. With stoves and fireplace inserts from HAAS+SOHN you thus have the best equipment for the future and you can enjoy the blissful warmth of your home with a clean conscience.

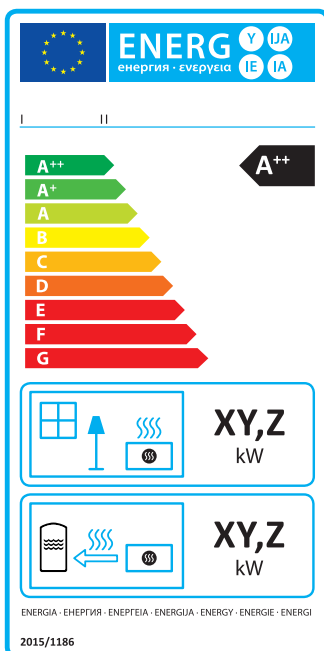

From 2018 - energy labels
for fireplace stoves



QUALITY TIMES

"In my work, I want only the best or nothing. And at home, this applies two-fold in my case. Functionality, peak quality and character count. When I am convinced about something, it becomes part of my life. Just like my fireplace set from HAAS+SOHN".

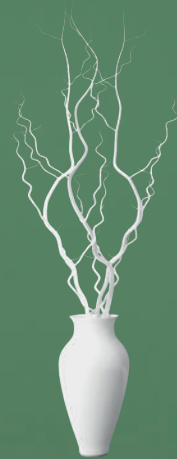

FIREPLACE STOVES



Better than watching TV

Is there anything better than sitting comfortably together in front of the stove, enjoy the heat and watch the "fiery window"? We believe that nothing beats it. For this reason, our fireplace stoves have extraordinarily large glazed surfaces for the best view of the game of flames.

Simple operation philosophy

Using our Easy Control System, operation of the stoves is very simple!

- + simple and safe operation
- + less soot black thanks to new combustion technologies
- + low cleaning requirements
- + less unpleasant fine dust
- + maximum heating cost savings
- + higher efficiency - more heat with lower wood consumption
- + unhindered view of the fire thanks to permanent rinsing of the glass
- + new, air-cooled handle





PRODUCT HIGHLIGHTS FIREPLACE STOVES



Easy air regulation control

All three air inlets – primary, secondary, and tertiary – can be regulated by just one ergonomic controller. You benefit thanks to complete combustion, thus reducing your costs.



1. Start - heating:

For adequate air intake when kindling the fire, switch to “Start” and leave it at this position till the flames spread evenly after the fuel feed.



2. Heating:

For clean and efficient combustion, push the regulator after firing up to the “operation” position.



3. Closing:

To keep the heat in the room for a longer period, switch the regulator after heating to “0”. Thanks to the closable air intake, the heat from the fireplace stove will remain in the room and you can enjoy it for a long time afterwards.



AUTO-AIR-COAL Dual Control

The patented Dual Control Function allows the stove temperature to be set with automatic control when using coal briquettes and ensures a consistent room temperature with constant heat output. Regardless of whether it is a wood or coal stove, the air intake is automatically controlled thus ensuring excellent efficiency. With optimal ease of control, clean combustion, and heating cost savings.

When burning wood:



The HIGHER the combustion temperature, the LARGER the air intake into the combustion zone, thus achieving clean and perfect combustion without creating soot.

When burning coal briquettes:

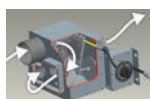

The HIGHER the combustion temperature, the LOWER the air intake into the combustion zone, thus achieving extended combustion and continuous heat output.



Heat accumulation

For long-term radiation of heat.

Heat accumulation graph:

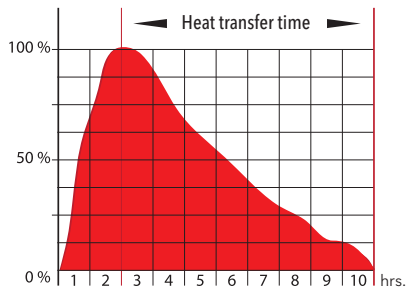

Heat transfer time
Heat transfer time after 3 wood feeds
of 2 kg each

After 2 hours of operation the stove is capable of emitting heat for the following 10 hours.

Accumulation Set:

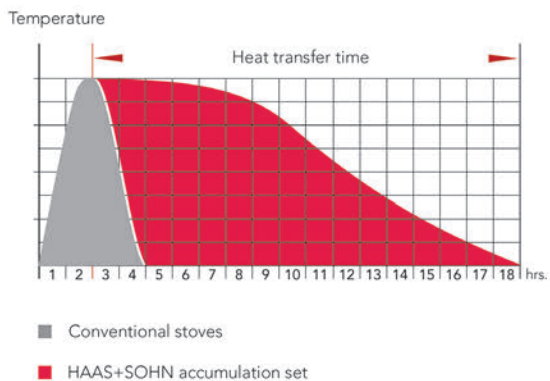

■ Conventional stoves
■ HAAS+SOHN accumulation set

Optional accessory for SALZBURG and OVALIS fireplace sets. Made of magnesite (density 4): The new accumulation set from the company HAAS+SOHN has double the accumulation capability of talc!

The accumulation set can be added at any time and is easy to install.



External combustion air supply

The option of a combustion air supply from outside. Heated air from the room is not burned. This is very suitable for well-insulated rooms.



Separate Air Intake

Fireplace sets with RLU (certified by DIBt) are perfectly suitable for low-energy and passive houses, as well as thermally rehabilitated buildings. The combustion air is taken in from the exterior and is separate from the air in the interior spaces. This allows controlled ventilation of habitable rooms.



Automatically Closable Doors

The stove door latch gently closes and locks independently.



Automatic Air Control

Fully automatic air intake control without a power supply. This ensures clean and optimal combustion. Less cleaning and additional heat cost savings.



Continuous operation using coal

By using brown-coal briquettes, any feed may be postponed even up to 12 hours, and lower fuel consumption and greater comfort can be achieved.

Natural element – stone facing

HAAS+SOHN uses natural stone as the design element in a number of its products.

As a natural element, every piece of stone should be seen as unique as far as its colour and structure.



PRODUCT HIGHLIGHTS

i-CONTROL

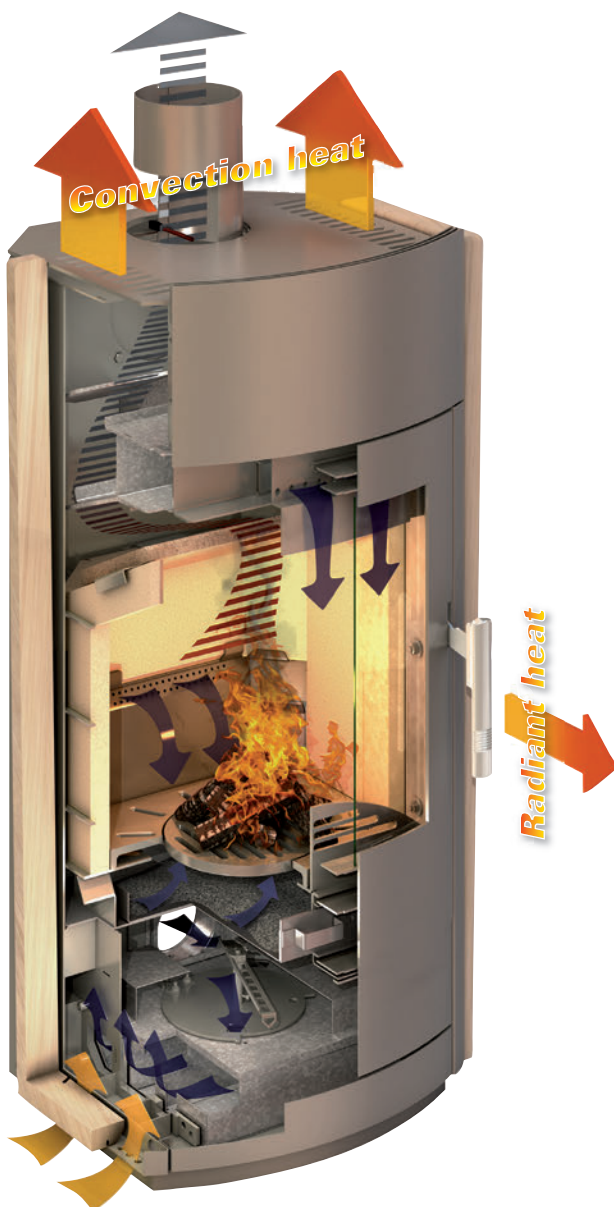

"i-control" Fully Automatic Electronic Air Control

The i-control function controls the stove air inlets with a small electronic motor (only 6 W during operation). The corresponding air inlets are opened or closed depending on the combustion temperature.

Primary air - allows rapid ignition and residue-free combustion

Secondary air - ensures clean combustion

Nozzle air - burns residual elements which can still be burned in the flue gases and thereby reduces emissions.

- + electronic control to ensure the lowest emissions
- + 60% lower emissions compared to standard fireplace sets
- + energy and heating cost savings
- + LED light diode status indicator
- + power consumption of only 6 W/h during operation



1



2

i-2100

HIGHLIGHTS



Fully automatic electronic air control
our patented TOP combustion technology



External combustion air supply
ideal for low-energy houses



Tertiary combustion
double combustion saves the amount of fuel needed

YOUR BENEFITS

- 3-point closing
- Saves space - depth of only 48.6 cm
- LED light diode status indicator
- Automatic secondary combustion control

	MODEL i-2100 1	i-2100 2
Colour	black / Serpentino	black / Woodstone Prestige
Efficiency	82 % A+	82 % A+
Capacity	8.3 kW	8.3 kW
Dimensions h / w / d	1,132 / 598 / 511 mm	1,132 / 598 / 511 mm
Order nr.	0424718660000	0424718670000



1



2

HERBORN II

HIGHLIGHTS



Easy control

Easy control air inlet regulation – easy air supply regulation control with just one regulator



Tertiary combustion

double combustion saves the amount of fuel needed



External combustion air supply

ideal for low-energy houses

YOUR BENEFITS

- Closable air inlet
- Quality cast-iron door

	MODEL	HERBORN II ¹	HERBORN II ²
Colour	grey		black
Efficiency	81 %	A⁺	81 % A⁺
Capacity	6.4 kW		6.4 kW
Dimensions h / w / d	942 / 492 / 519 mm		942 / 492 / 519 mm
Order nr.	0429515610000		0429515600000



1



2

MADEIRA

HIGHLIGHTS



Easy control

Easy control air inlet regulation – easy air supply regulation control with just one regulator



Tertiary combustion

double combustion saves the amount of fuel needed



External combustion air supply

ideal for low-energy houses

YOUR BENEFITS

- Closable air inlet
- 3-point closing

MODEL	MADEIRA ¹	MADEIRA ²
Colour	black / Woodstone Prestige	black / Speckstein antik
Efficiency	82 % A⁺	82 % A⁺
Capacity	2.1-6.4 kW	2.1-6.4 kW
Dimensions h / w / d	996 / 606 / 492 mm	996 / 606 / 492 mm
Order nr.	0429617500000	0429617520000



1



2







3



4



OVALIS

HIGHLIGHTS

-  **Automatic air control**
the easiest and most convenient control
-  **External combustion air supply**
ideal for low-energy houses
-  **Automatic door**
with gently closing door latch
-  **Heat accumulation**
for long-term radiation of heat

YOUR BENEFITS

- Closable air inlet
- Automatic secondary combustion control
- Saves space – depth of only 46.4 cm

	1	2	3	4
MODEL	OVALIS GRANDE	OVALIS PICCOLO	ACCUMULATION SET	KNIE FOR REAR FLUE BY OVALIS WITHOUT EXCHANGER
Colour	black	black	70 kg	Ø 150 mm, 90°
Efficiency	81 % 	81 % 		
Capacity	2.5–5 kW	2.5–5 kW		
Dimensions h / w / d	1,550 / 464 / 464 mm	1,170 / 464 / 464 mm		
Order nr.	0428612620000	0428612610000	0428650500000	0332015007065

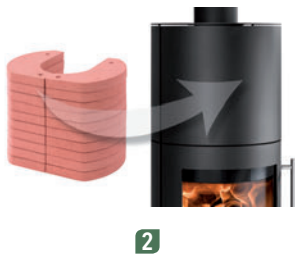

2



3



1

OVALIS RLU

HIGHLIGHTS



Automatic air control
the easiest and most convenient control



External combustion air supply
ideal for low-energy houses



Automatic door
with gently closing door latch



Heat accumulation
for long-term radiation of heat



Separate air intake
does not require air from the room for heating purposes

YOUR BENEFITS

- Closable air inlet
- Automatic secondary combustion control
- Saves space – depth of only 46.4 cm

MODEL	OVALIS RLU GRANDE 1	ACCUMULATION SET 2	KNIE FOR REAR FLUE BY OVALIS WITHOUT EXCHANGER 3
Colour	black	70 kg	Ø 150 mm, 90°
Efficiency	87 % A+		
Capacity	2.6-5.4 kW		
Dimensions h / w / d	1,550 / 464 / 464 mm		
Order nr.	0429112520000	0428650500000	0332015007065



1



2

PINEROLO

HIGHLIGHTS



Easy control

Easy control air inlet regulation – easy air supply regulation control with just one regulator



Tertiary combustion

double combustion saves the amount of fuel needed



External combustion air supply

ideal for low-energy houses



Heat accumulation

for long-term radiation of heat

YOUR BENEFITS

- Closable air inlet
- Quality cast-iron door

	MODEL	PINEROLO ¹	PINEROLO ²
Colour		black / Woodstone Prestige	black / Speckstein
Efficiency		81 % A⁺	81 % A⁺
Capacity		3-6.4 kW	3-6.4 kW
Dimensions h / w / d		1,004 / 540 / 477 mm	1,004 / 540 / 477 mm
Order nr.		0429415600000	0429415630000



1



2

RONDO

HIGHLIGHTS



External combustion air supply
ideal for low-energy houses

YOUR BENEFITS

- 3-point closing
- Automatic secondary combustion control

MODEL	RONDO 1	RONDO 2
Colour	anthracite / Serpentino	anthracite / Paradiso
Efficiency	81 % A+	81 % A+
Capacity	3.6-8.6 kW	3.6-8.6 kW
Dimensions h / w / d	1,128 / 615 / 507 mm	1,128 / 615 / 507 mm
Order nr.	0424918610000	0424918620000



1



2

DOOR

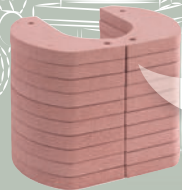

3



TOP COVER SALZBURG EASY

Serpentino
- without opening for upper outlet
Order nr. 0335015101100



TOP COVER SALZBURG EASY

Serpentino
- with opening for upper outlet
Order nr. 0335015101200

SALZBURG EASY

HIGHLIGHTS



Easy control

Easy control air inlet regulation - easy air supply regulation control with just one regulator



Tertiary combustion

double combustion saves the amount of fuel needed



External combustion air supply

ideal for low-energy houses



Heat accumulation

for long-term radiation of heat

YOUR BENEFITS

- Closable air inlet
- 3-sided glass
- Saves space - depth of only 38 cm

MODEL	SALZBURG EASY 351.15 ¹	SALZBURG EASY 351.15 ²	ACCUMULATION SET ³	COVER CAP WHEN USING REAR FLUE
Colour	black / firewood box	black / sealable firewood box	70 kg	black
Efficiency	80 % A⁺	80 % A⁺		
Capacity	7.3 kW	7.3 kW		
Dimensions h / w / d	1,555 / 482 / 380 mm	1,555 / 482 / 380 mm		
Order nr.	0335115120000	0335115010000	0428650500000	0335015006188



BENCH – MODULES FOR SALZBURG EASY



MODEL	1 SALZBURG DOUBLE BENCH	2 SIMPLE SALZBURG BENCH	3 SALZBURG CORNER BENCH	4 PARTITION FOR SALZBURG BENCH
Colour / design	black with shelf	black with shelf	black	
Dimensions h / w / d	460 / 964 / 365 mm	460 / 482 / 365 mm	460 / 365 / 365 mm	
Order nr.	0335017630000	0335017620000	0335017650000	0335017700000



PRODUCT HIGHLIGHTS FIREPLACE STOVES WITH HEAT EXCHANGER



Smart heating with HAAS+SOHN

Use our fireplace stove for central heating and save the environment. The fireplace stove with exchanger combines the comfortable warm atmosphere of fireplace stoves with the efficiency of central heating. They intelligently utilise the overall energy, optimise the efficiency of the central heating system and prevent radiation losses. You can thus enjoy the crackling of fire from the fireplace stove, heat ecologically, and save heating costs with a clear conscience!

- ✚ self-sufficient, energy saving heating
- ✚ direct heating of the room
- ✚ and more than 70% of heat transferred to the heating system
- ✚ perfect heating alternative in the transitional period



Heat exchanger cleaning

Patented heat exchanger cleaning technology. A unique system of convenient cleaning of the exchanger, protected by the Industrial Property Office of the Czech Republic as a usable sample.

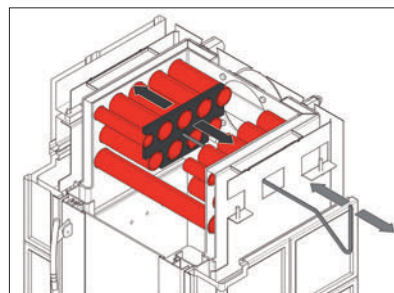

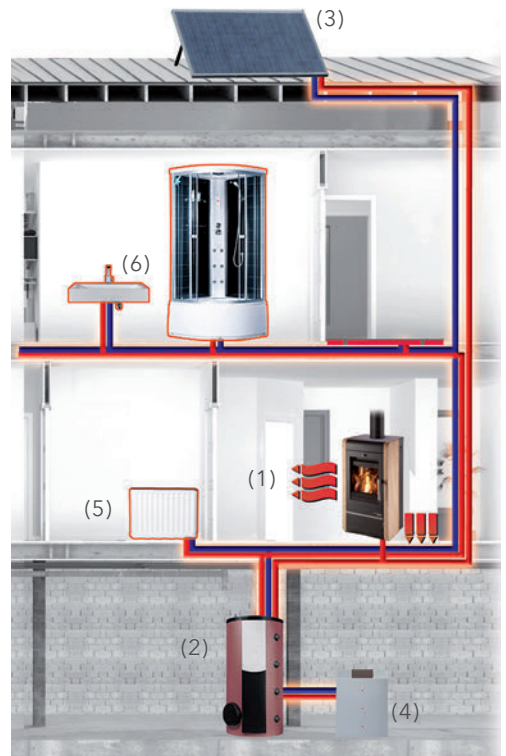

Some of the heat is directly utilised for heating the room in which the stove is located (1). The rest is stored in the accumulation reservoir (2), which can also be supplied from other energy sources, such as solar panels (3) and boilers (4). When needed, heat is transferred from the reservoir to the heating system (radiators) (5) or used, e.g., for heating water (6).

Warning:

The exchanger cannot be used without a hot-water connection. Connection to the heating system must be carried out by a professional company.



Automatic primary combustion air regulator

During a power outage, when water in the exchanger reaches 95 °C, this closes the primary air inlet into the firing chamber with the help of a special thermostatic capillary valve, which makes combustion impossible.







Replaceable exchanger

The heat exchanger can be added to stoves or removed and replaced with the dummy plug at any time. This feature is advantageous in cases when the stove is connected or disconnected from the heating system. Overall stove servicing is simplified due to this feature.



FARUM WITH HEAT EXCHANGER

HIGHLIGHTS

-  **Tertiary combustion**
double combustion saves the amount of fuel needed
-  **Heat exchanger cleaning**
simple and clean
-  **External combustion air supply**
ideal for low-energy houses
-  **Automatic primary combustion air regulator**
prevents problems during power outages

YOUR BENEFITS

- Option to add a cooling loop
- Replaceable exchanger

	MODEL FARUM	COOLING LOOP
Colour	black / Woodstone Prestige	
Efficiency	87 % 	
Cap. (for heat. elements)	4.9-14.9 kW (11.1 kW)	
Dimensions h / w / d	1,217 / 624 / 632 mm	
Order nr.	0433437000000	0432317006108



VISBY WITH HEAT EXCHANGER

HIGHLIGHTS



Easy control

Easy control air inlet regulation – easy air supply regulation control with just one regulator



Tertiary combustion

double combustion saves the amount of fuel needed



Heat exchanger cleaning

simple and clean



External combustion air supply

ideal for low-energy houses

YOUR BENEFITS

- Option to add a cooling loop
- Closable air inlet
- 3-point closing

	MODEL VISBY	COOLING LOOP
Colour	black / Woodstone Prestige	
Efficiency	81 % 	
Cap. (for heat. elements)	3.3–10.2 kW (7.2 kW)	
Dimensions h / w / d	1,012 / 483 / 566 mm	
Order nr.	0434515500000	0434515006108



QUALITY TIMES

"Is there such a thing as a symphony of heat? My violin could say a thing or two about it. It is a personality, and I would never want to play any other violin. I practise and learn every day. The heat from my HAAS+SOHN pallet stove accompanies me as I play".



PELLET STOVES



New generation heating

The pellet stove with WLAN function provides maximum freedom thanks to remote control accessible from any point worldwide - absolutely independent of the location. And besides the comfort of pellet stoves, they also afford a romantic view of the flames almost like it applies to the fireplace stoves - only at HAAS+SOHN.

- + easy operation
- + highest operating comfort
- + fully automatic heat regulation
- + energy efficient heating
- + almost noise-free operation
- + suitable for allergic persons
- + easy cleaning





PRODUCT HIGHLIGHTS PELLET STOVES



Pellet stove with WLAN module New generation heating

For greater mobility and freedom. So your home is always warm - regardless of your current location. You equip your pellet stove with a multifunctional WLAN module from HAAS+SOHN and use 2 types of remote control devices. You either control your pellet stove via a smartphone using the "Local" function, i.e. in and around your home, or "Global", i.e. from any location worldwide. The module does not need any additional network connection.

Simply connect it to the pellet stove and its ready! HAAS+SOHN so simply and comfortably takes care of Your

QUALITY TIMES

HAAS+SOHN application Complete control via a smartphone

Simply download the application free-of-charge and you can go ahead! Full control of your pellet stove is possible easily and simply with the HAAS+SOHN application.

- + Easy setting of the weekly program via a smartphone
- + Via this application, up to 5 members of the family can connect to one or more pellet stoves and simultaneously control up to 5 pellet stoves
- + Push-notification - your pellet stove communicates with you via the smartphone even when it is not active. It informs you about cleaning and failures.
- + SL data security offers everything you need for secure communication





Large glazed area

The view of the flames is almost identical to that of classic wood, thus bringing about a pleasant feeling of comfort.



Friendly for allergy suffer thanks to the heat exchanger

Enjoy the radiation of natural heat and its flow completely without an air fan in the room. Rising of dust and other particles is controlled, the air quality is maintained, the eyes and respiratory system are protected.



Simple operation

Comfortable and simple control with just four pushbuttons. Display with a well-arranged menu.



Fully automatic temperature control

Variable setting of the required room temperature at various time intervals eliminates frequent turning on and off of stoves. Thus, you reduce heating costs, protect the environment, reduce fouling and the need for cleaning.



1



2



3

HSP 6 PREMIUM 32

HIGHLIGHTS



WLAN

optional feature Wlan Local & Global



Fully automatic temperature control

the optimum room temperature exactly when you need it



Friendly for allergy suffer

thanks to the heat exchanger



Large glazed area

YOUR BENEFITS

- External combustion air supply
- Quality cast-iron door
- Large pellet container
- Weekly programming



ROOM TEMPERATURE SENSOR

cable 8 m

Order nr. 0532007010000

MODEL	HSP 6 PREMIUM 32 1	WLAN MODULE 2	DESIGNER BASES 3
Colour	grey / black		
Efficiency	90 % A+		
Capacity	8 kW		
Dimensions h / w / d	1,200 / 502 / 503 mm		0552108001395 (black-SET) 0552108001396 (nickel-SET)
Order nr.	0553908500000	0532007100000	



PRODUCT HIGHLIGHTS PELLET STOVES WITH HEAT EXCHANGER



Smart heating with HAAS+SOHN

Use our pellet stove for central heating and save the environment. The pellet stove with exchanger combine the comfortable warm atmosphere of pellet stoves with the efficiency of central heating. They intelligently utilise the overall energy, optimise the efficiency of the central heating system and thus prevent radiation loss. You can thus enjoy the warmth of the fire from the pellet stove, heat ecologically, and save heating costs with a clear conscience!

- ✚ self-sufficient, energy saving heating
- ✚ direct heating of the room
- ✚ indirect heating of the rest of the rooms
- ✚ perfect heating alternative in the transitional period
- ✚ optimal efficiency and operating comfort with WLAN control

Heat exchanger

Some of the heat is directly utilised for heating the room in which the stove is located. The rest is stored in the accumulation reservoir, which can also be supplied from other energy sources, such as solar panels and boilers. When needed, heat is transferred from the reservoir to the heating system (radiators) or used, e.g., for heating water.

Warning: The exchanger cannot be used without a hot-water connection. Connection to the heating system must be carried out by a professional company.

Heat exchanger cleaning

Patented heat exchanger cleaning technology. A unique system of convenient cleaning of the exchanger, protected by the Industrial Property Office of the Czech Republic as a usable sample.





Hydraulic module

This auxiliary module can be installed in the stove in such a manner that it almost does not take-up any space.

It comprises:

- ✚ a circulation pump,
- ✚ a safety valve,
- ✚ a triple valve,
- ✚ a pressure valve,

it ensures the small heat circuit of the stove.

Possibility to choose a rear or bottom (floor) connection.

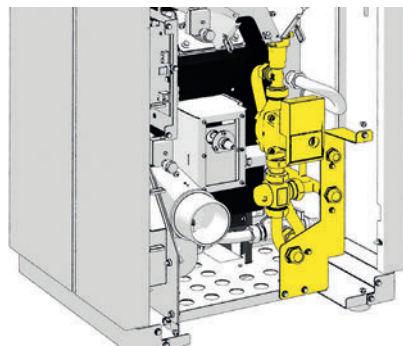









HSP 6 WITH HEAT EXCHANGER



HIGHLIGHTS

-  **WLAN**
optional feature Wlan  Local &  Global
-  **Fully automatic temperature control**
the optimum room temperature exactly when you need it
-  **Extremely quiet operation**
almost noiseless
-  **Large glazed area**

YOUR BENEFITS

- Fuel quality recognition
- Safety functions



ROOM TEMPERATURE SENSOR

cabl 8 m

Order nr. 0532007010000

	1	2	3	4
MODEL	HSP 6	HSP 6	WLAN MODULE	HYDRAULIC MODULE
Colour	anthracite / black	anthracite / white		
Efficiency	94 % A++	94 % A++		
Cap. (for heat. elements)	10 kW (7.9 kW)	10 kW (7.9 kW)		
Dimensions h / w / d	1,200 / 545 / 498 mm	1,200 / 545 / 498 mm		
Order nr.	0553808500000	0553808510000	0532007100000	0553808214000

ACCESSORIES

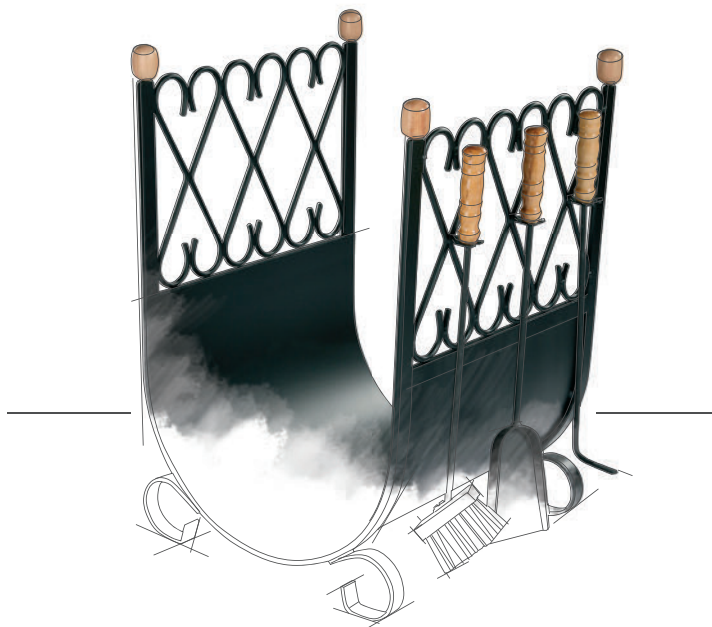

The fireplace stove or fireplace essentially need accessories that combine your interior with a design element and also provide a practical tool for maintaining your heater.

- + visual improvement of your stove
- + patented technology of air draft for higher energy saving
- + practical and simultaneously a design element for your home

FIREPLACE TOOLS



FIREPLACE TOOLS

BAU IV - THREE-PIECE	HS III - THREE-PIECE
Dimensions 58 x 20 x 20 cm	76.5 x 22 x 22 cm
Colour black, wood	anthracite, chromium-coated handle
Order nr. 1116002200000	1130140140000

CLEANING SPRAYS



GLASS CLEANER

Volume	500 ml
Order nr.	1116000200000

LOG BASKETS



LOG BASKETS

ANGULAR LITTER BIN	MIDDLE BASKET	OVAL BASKET	BASKET BIG (WITHOUT / WITH INSTRUMENTS)	BASKET DERBY (WITH INSTRUMENTS)
Dimensions 35 x 46 x 30 cm	40 x 24 x 36 cm	46 x 22 x 32 cm	68 x 48 x 45 / 70 x 49 x 46 cm	68 x 48 x 45 cm
Colour black	black, wood	black, wood	black, wood	anthracite, wood
Order nr. 1116002700000	1116002500000	1116002400000	1116002600000 / 1116001600000	1116003000000

ENERGY SAVING-DRAUGHT CONTROLLERS

Zugex H+S chimney draught regulator



Zugregler H+S chimney draught regulator



CONTROLLER	ZUGEX H+S 130	ZUGEX H+S 150	ZUGEX H+S 200
Order nr.	1120130110000	1120150110000	1120200110000

CONTROLLER	ZUGREGLER H+S 130	ZUGREGLER H+S 150	ZUGREGLER H+S 200
Order nr.	1120130010000	1120150010000	1120200010000

REPAIRING SPRAYS



REPAIRING SPRAY	COLOUR BLACK	COLOUR ANTHRACITE
Volume	400 ml	400 ml
Order nr.	0070200050005	0070200020005

REPAIRING SPRAY	COLOUR SILVER	COLOUR BORDEAUX
Volume	400 ml	400 ml
Order nr.	0070200040005	0070200070005

FIREPLACE STOVE GLASS FLOOR PLATES MADE OF 6 MM THICK HARDENED GLASS



Elegant and safe

- ✚ visual enhancement of your stove
- ✚ floor surface protection
- ✚ 6 mm thick hardened glass with polished edge
- ✚ fire protection of flammable floors (e.g. wooden floors)

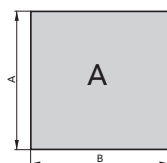

**GLASS FLOOR PLATES
- FORM "A"**

Dimensions 900 x 750 mm

Order nr. 1115409200000

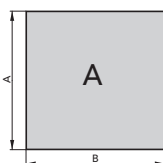

**GLASS FLOOR PLATES
- FORM "A"**

Dimensions 1,000 x 1,000 mm

Order nr. 1115410200000

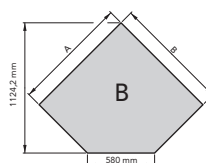

**GLASS FLOOR PLATES
- FORM "B"**

Dimensions 1,000 x 1,000 mm /
580 mm 45°

Order nr. 1115510200000

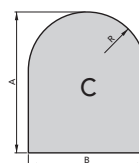

**GLASS FLOOR PLATES
- FORM "C"**

Dimensions 1,000 x 1,000 mm /
R = 500 mm

Order nr. 1115910200000

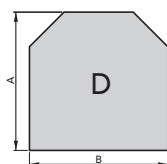

**GLASS FLOOR PLATES
- FORM "D"**

Dimensions 1,000 x 1,000 mm

Order nr. 1115610200000

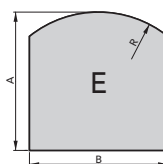

**GLASS FLOOR PLATES
- FORM "E"**

Dimensions 1,000 x 1,000 mm /
R = 800 mm

Order nr. 1115910300000

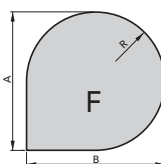









**GLASS FLOOR PLATES
- FORM "F"**

Dimensions 1,000 x 1,000 mm /
R = 500 mm









Order nr. 1115910400000

TECHNICAL PARAMETERS

FIREPLACE STOVES

Page	Model									
13	i-2100	234	30 cm	150	150	150	2.3	•		12
14	HERBORN II	115	33 cm	150	150	115	1.61			12
15	MADEIRA	130	33 cm	150	150	55-115	0.5-1.6	•		12
16	OVALIS (Grande/Piccolo)	127/118	30 cm	150	150	90	1.25			12
17	OVALIS RLU	128	30 cm	150	150	97	1.5			12
18	PINEROLO (Woodstone/Speckstein)	179/197	33 cm	150	150	115	1.61	•		12
19	RONDO	187	33 cm	150	150	155	2.5	•	•	12
20	SALZBURG EASY (Box/Door)	124/129	33 cm	150	150		1.5	•		12

FIREPLACE STOVES WITH HEAT EXCHANGER

Page	Model									
24	FARUM WITH HEAT EXCHANGER	221	33 cm	150		90-268	0.9-4.1	•	•	12
25	VISBY WITH HEAT EXCHANGER	180	33 cm	150		184	3	•	•	12

PELLET STOVES

Page	Model								
30	HSP 6 PREMIUM 32		146		80	144	1.94	32	6

PELLET STOVES WITH HEAT EXCHANGER

Page	Model								
33	HSP 6 WITH HEAT EXCHANGER		174		80	250	2.1	32	6

EXPLANATORY NOTES



Weight (kg)



Environment friendly pressed fuel



Lump wood (max. length in cm)



Brown-coal briquettes



Top flue-gas outlet (Ø mm)



Volume of pellet container (kg)



Rear flue-gas outlet (Ø mm)



Chimney draught (Pa)



Heating ability (m³)



Fuel consumption (kg/h)

HAAS
+
SOHN

QUALITY TIMES

Warmth. Salzburg style.





QUALITY TIMES

COLLECTION 2018/19

HAAS+SOHN RUKOV s. r. o. 

SNP 474
408 01 Rumburk
Czech Republic

Phone: +420 412 332 351-3

odbyt@haassohn.com
www.haassohn-rukov.cz/en

Your HAAS+SOHN dealer:



The manufacturer reserves the right to minor design and technical changes.

Effective to 03/2019.

Order nr. 9042000100054.